

CSE-200

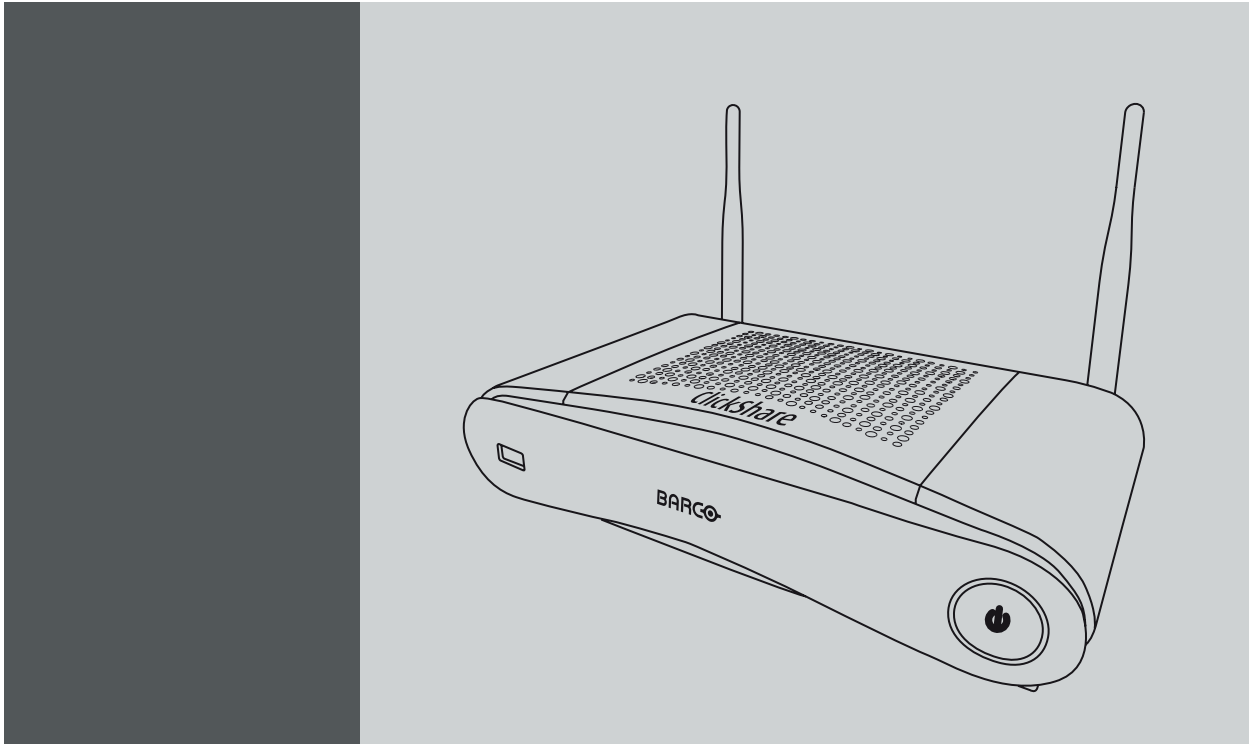

User guide

Barco NV

President Kennedypark 35, 8500 Kortrijk, Belgium

Phone: +32 56.23.32.11

Fax: +32 56.26.22.62

Support: www.barco.com/en/support

Visit us at the web: www.barco.com

Copyright ©

All rights reserved. No part of this document may be copied, reproduced or translated. It shall not otherwise be recorded, transmitted or stored in a retrieval system without the prior written consent of Barco.

Trademarks

Brand and product names mentioned in this manual may be trademarks, registered trademarks or copyrights of their respective holders. All brand and product names mentioned in this manual serve as comments or examples and are not to be understood as advertising for the products or their manufacturers.

Guarantee and Compensation

Barco provides a guarantee relating to perfect manufacturing as part of the legally stipulated terms of guarantee. On receipt, the purchaser must immediately inspect all delivered goods for damage incurred during transport, as well as for material and manufacturing faults Barco must be informed immediately in writing of any complaints.

The period of guarantee begins on the date of transfer of risks, in the case of special systems and software on the date of commissioning, at latest 30 days after the transfer of risks. In the event of justified notice of complaint, Barco can repair the fault or provide a replacement at its own discretion within an appropriate period. If this measure proves to be impossible or unsuccessful, the purchaser can demand a reduction in the purchase price or cancellation of the contract. All other claims, in particular those relating to compensation for direct or indirect damage, and also damage attributed to the operation of software as well as to other services provided by Barco, being a component of the system or independent service, will be deemed invalid provided the damage is not proven to be attributed to the absence of properties guaranteed in writing or due to the intent or gross negligence or part of Barco.

If the purchaser or a third party carries out modifications or repairs on goods delivered by Barco, or if the goods are handled incorrectly, in particular if the systems are operated incorrectly or if, after the transfer of risks, the goods are subject to influences not agreed upon in the contract, all guarantee claims of the purchaser will be rendered invalid. Not included in the guarantee coverage are system failures which are attributed to programs or special electronic circuitry provided by the purchaser, e.g. interfaces. Normal wear as well as normal maintenance are not subject to the guarantee provided by Barco either.

The environmental conditions as well as the servicing and maintenance regulations specified in this manual must be complied with by the customer.

Barco ClickShare End-User License Agreement (EULA/Software License)

PLEASE READ THIS DOCUMENT CAREFULLY BEFORE OPENING OR DOWNLOADING AND USING SOFTWARE OR HARDWARE PROVIDED TO YOU BY BARCO AS IT CONTAINS THE TERMS AND CONDITIONS BY WHICH BARCO OFFERS TO LICENSE THE SOFTWARE. BY OPENING THE SOFTWARE PACKAGE, OR USING THE HARDWARE IN WHICH THE SOFTWARE IS EMBEDDED, YOU AGREE TO BECOME BOUND BY THE TERMS OF THIS AGREEMENT.

The Software as supplied by BARCO is licensed, not sold to you, on a non-exclusive basis for use only under the terms of this license, and BARCO reserve all rights not expressly granted to you. You may own the carrier on which the Software is provided, but the Software is owned and copyrighted by BARCO or by third party suppliers. Your license confers no title or ownership and is not a sale of any rights in the Software or its documentation.

By installing, executing and/or using the Software, either as initial version or as an upgrade, update, patch or enhancement of a prior release, this Software License shall supersede any terms and conditions previously agreed upon (whether or not in writing) between Barco and you with respect to the subject matter of this Software License and such previous terms shall from the date hereof cease to have any force or effect; provided, however that this Software License shall not be construed as a renunciation, discharge or waiver of any right or remedy provided in any terms and conditions previously agreed upon with respect to a failure of either party to perform any of its obligations under any terms and conditions previously agreed upon.

Software Specifications

The Software contains the following software products: ClickShare

Software License Terms

1. This Software License is between you and BARCO NV, a corporation organized and existing under the laws of Belgium registered under number BE 0473.191.041, Commercial Companies' Register of Kortrijk, having its registered office President Kennedypark, 35 at B-8500 Kortrijk, Belgium ("Barco") for the use of the Software.
You hereby undertake to inform all users authorized by you to make use of the computing device on which the Software is loaded/installed ("Authorized Users") of the terms of this Software License and to bind all Authorized Users to accept all such terms of this Software License as applies to them.
2. Barco grants you a limited, non-exclusive, non-assignable, non-transferable user license (without the right to grant sublicenses). Unless specifically agreed upon otherwise between you and Barco or unless specifically allowed by the Software (or its DRM management) itself, i) the license under this Software License applies to one (1) copy of the Software to be used on one single computing device and ii) installation on a computing device that may be concurrently accessed by more than one user shall not constitute a permitted use and a separate license is required for each active user connected to a computing device on which the Software is being used.
You and Authorized Users are entitled to use the Software for the purposes and in the manner set out in this Software License (and documentation), but neither you nor any Authorized User are entitled to: (i) sell or grant a security interest in the Software to other parties in any way, or to rent, lease or sub-license the Software to others without the express prior written consent of Barco; or (ii) exploit the Software or any of its component parts for any commercial purpose, other than use by you and/or Authorized Users of the Software.
Neither you nor any Authorized User may, whether in whole or in part, copy, translate, reverse engineer, derive source code from, modify, disassemble, decompile, create derivative works based on the Software, or remove any proprietary notices or labels on the Software, save as may be permitted by law or this Software License, without the prior consent, in writing, of Barco.
3. Barco (and Barco's licensors, as appropriate) retain ownership of all intellectual property rights in the Software and any copies you or any Authorized User may make of such Software. The Software is protected by national copyright laws, international copyright treaties and conventions, and other applicable laws. All rights not expressly licensed to you in this Software License are reserved to Barco and Barco's licensors, as appropriate. The Software contains certain other licensed materials and Barco's licensors may protect their rights in the event of any violation of this Software License.
4. Barco shall hold you harmless, defend and indemnify you from and against direct damages, losses and expenses arising from infringement or alleged infringement of any patent, trademark or copyright of such third party by the license and the right to install the Software as permitted by this Software License and settle at its sole expense any amounts awarded in a final judgment or settlement resulting therefrom, under the condition that (i) you promptly notify Barco in writing after a claim has been asserted against you or the commencement of any claim, action, suit or proceeding (whichever is the earlier), and (ii) Barco shall be allowed to assume sole control of the defense and any settlement negotiations related to any claim, action, suit or proceeding, and (iii) you shall not negotiate, settle or compromise any claim, action, suit or proceeding without the prior written consent of Barco and (iv) you, at your cost, shall cooperate with Barco and provide assistance and support, as may reasonably be required by Barco, in connection with the defense and any settlement negotiations related to any claim, action, suit or proceeding. Barco shall have no indemnity obligation for any Software, or any portion thereof, (i) that is based on specifications, drawings, models or other data furnished by you or, (ii) that is not provided by Barco or, (iii) that is modified, in spite of the prohibition for you to modify the software or, (iv) to the extent that you continue allegedly infringing activity after having been provided modifications that avoid the alleged infringement, or (v) where the use of the Software, or the combination or thereof with other Software, processes or materials or the distribution thereof rather than the Software itself is the primary cause of an alleged infringement. In case it has been determined by a finally awarded judgment that Barco infringed or misappropriated such third party rights or earlier, at Barco's discretion, it may, at its option and cost, (i) modify the Software in such a way that it shall not infringe upon or misappropriate the rights of the third party or (ii) obtain for you a license or other right to use the rights allegedly infringed or (iii) replace the Software in question with non-infringing Software. The remedies set forth in this paragraph shall constitute your sole and exclusive remedy and Barco's sole and exclusive liability for a third party claim that the Software infringes or misappropriates any intellectual property right of a third party.
5. The duration of this Software License will be from the date of your acceptance (as set forth above) of the Software (whereby you acknowledge that use of the Software implies acceptance), with no termination date, unless otherwise specified. You may terminate this Software License at any time by destroying all copies of the Software then in your possession and returning all associated materials and documentation, to Barco or the appointed Barco reseller that sold or provided these to you. Barco may terminate this Software License forthwith by informing you at any time if you and/or any Authorized User are in breach of any of the Software License's terms.

6. YOU UNDERSTAND THAT THE SOFTWARE IS BEING PROVIDED TO YOU "AS IS". BARCO DOES NOT MAKE NOR INTENDS TO MAKE ANY WARRANTIES OR REPRESENTATIONS, EXPRESS OR IMPLIED AND SPECIFICALLY DISCLAIMS ALL IMPLIED WARRANTIES OF MERCHANTABILITY FITNESS, FOR A PARTICULAR PURPOSE AND NON-INFRINGEMENT OF INTELLECTUAL PROPERTY AND DOES NOT WARRANT THAT THE SOFTWARE WILL BE FREE FROM ERRORS OR THAT SUCH ERRORS WILL BE CORRECTED BY BARCO AND YOU ARE SOLELY RESPONSIBLE FOR ALL COSTS AND EXPENSES ASSOCIATED WITH RECTIFICATION, REPAIR OR DAMAGE CAUSED BY SUCH ERRORS.

YOU ALSO ACKNOWLEDGE AND AGREE THAT:

BARCO ACCEPTS NO LIABILITY FOR ANY DAMAGES, LOSSES OR CLAIMS YOU OR ANY THIRD PARTY MAY SUFFER AS A RESULT OF YOUR USE OF THE SOFTWARE. IN JURISDICTIONS WHERE BARCO'S LIABILITY CANNOT BE EXCLUDED, BARCO'S LIABILITY FOR DIRECT DAMAGES SHALL BE LIMITED TO AN AMOUNT OF 250 EURO IN THE AGREGATE (OR TO THE MAXIMUM EXTENT PERMITTED BY LAW WHERE NO FURTHER EXCLUSION IS LEGALLY ALLOWED).

TO THE MAXIMUM EXTENT PERMITTED BY LAW, IN NO EVENT WILL BARCO BE LIABLE FOR ANY INDIRECT, SPECIAL, PUNITIVE, INCIDENTAL OR CONSEQUENTIAL LOSS OR DAMAGES OF ANY KIND WHICH MAY ARISE OUT OF OR IN CONNECTION WITH THE SOFTWARE, THIS SOFTWARE LICENSE OR THE PERFORMANCE OR PURPORTED PERFORMANCE OF OR FAILURE IN THE PERFORMANCE OF BARCO'S OBLIGATIONS UNDER THIS SOFTWARE LICENSE OR FOR ANY ECONOMIC LOSS, LOSS OF BUSINESS, CONTRACTS, DATA, GOODWILL, PROFITS, TURNOVER, REVENUE, REPUTATION OR ANY LOSS ARISING FROM WORK STOPPAGE, COMPUTER FAILURE OR MALFUNCTION OF THE SOFTWARE AND ANY AND ALL OTHER COMMERCIAL DAMAGES OR LOSSES WHICH MAY ARISE IN RESPECT OF USE OF THE SOFTWARE, EVEN IF BARCO HAS BEEN ADVISED OF THE POSSIBILITY OF THEIR OCCURRENCE.

YOU HEREBY AGREE TO INDEMNIFY, KEEP INDEMNIFIED, DEFEND AND HOLD HARMLESS BARCO AND BARCO'S AFFILIATES AND SUBSIDIARIES FROM AND AGAINST ANY AND ALL ACTIONS, PROCEEDINGS, LIABILITY, LOSS, DAMAGES, FEES AND COSTS (INCLUDING ATTORNEYS' FEES), AND OTHER EXPENSES INCURRED OR SUFFERED BY BARCO ARISING OUT OF OR IN CONNECTION WITH ANY BREACH BY YOU OF THE TERMS OF THIS SOFTWARE LICENSE.

7. You shall treat as confidential all information obtained from the other pursuant to this Software License which is marked "confidential" or the equivalent or has the necessary quality of confidence about it and shall not divulge such information to any persons without Barco's prior written consent provided that this Paragraph 7 shall not extend to information which was rightfully in the possession of you prior to the commencement of the negotiations leading to this Software License, which is already public knowledge or becomes so at a future date (otherwise than as a result of a breach of this paragraph 7), is required to be disclosed by law or which is trivial or obvious. You are aware of and ensure to comply with the provisions of this paragraph 7. The foregoing obligations as to confidentiality shall survive any termination of this Software License.
8. You will remain responsible for the maintenance of your hardware, operating system, the functioning of your network and in keeping your systems virus-free. You acknowledge that the Software is a complex computer software application, and that the performance thereof may vary depending hardware platform, software interactions and configuration. You acknowledge that the Software is not designed and produced specifically to meet your specific requirements and expectations and the selection of the Software by you is entirely your own choice and decision. For the avoidance of doubt, nothing in this Software License shall impose any obligation on Barco to provide support services (on the Software or any other hardware or software product).
9. This Software License is the only understanding and agreement between you and Barco for use of the Software by you and/or Authorized Users. The Software License supersedes all other communications, understandings or agreements we had prior to this Software License (with the exception of any continuing confidentiality agreement) although nothing in this Software License purports to exclude liability for fraudulent misrepresentation. You may not export or re-export the Software or any copy or adaptation in violation of any applicable laws or regulations. This Software License shall not be altered, amended or varied. If any provision of this Software License is determined to be illegal, void or unenforceable, or if any court of competent jurisdiction in any final decision so determines, this Software License shall continue in full force save that such provision shall be deemed to be deleted with effect from the date of such decision, or such earlier date, and shall be replaced by a provision which is acceptable by law and which embodies the intention of this Software License as close as possible.
10. You acknowledge that this Software may be subject to U.S. or other governments Export Jurisdiction. You agree to comply with all applicable international and national laws that apply to the Software, including the U.S. Export Administration Regulations, as well as end-user, end-use, and destination restrictions issued by the U.S. or other governments.
11. Barco shall be entitled to sub-contract all or any of Barco's obligations hereunder to a third party and/or any of Barco's affiliated companies.
12. The construction, validity and performance of this Software License shall be governed in all respects by the laws of Belgium without recourse to its conflict of law principles. All disputes arising in any way out of or affecting this Software License shall be subject to the exclusive jurisdiction of the courts of Kortrijk, without prejudice to enforcement of any judgment or order thereof in any other jurisdiction. The United Nations Convention on Contracts for the International Sale of Goods (the "Convention") shall not apply to this Software License, however, if the Convention is deemed by a court of competent jurisdiction to apply to this Software License, Barco shall not be liable for any claimed non-conformance of the Software under Article 35(2) of the Convention.

Trademarks Software License Terms

Brand and product names mentioned in relation to the Software may be trademarks, registered trademarks or copyrights of their respective (third party) holders. All such brand and product names mentioned in relation to the Software serve as comments or examples and are not to be understood as advertising for the products or their manufacturers.

Privacy Policy

You acknowledge and agree that the Software is gathering technical information about the functionality of the products which are connected through the Software ("Functional Information") and that Barco may make use of such Functional Information (with the exclusion of any

personal data) for any reason Barco sees fit, including but not limited to providing services to you / your organization, allowing third party to access to such Functional Information and/or to provide services to you / your organization .

You hereby explicitly give consent that Barco may gather, access, preserve, and/or disclose the personal data you provide to us (e.g. connected with your account allowing for the gathering of Functional Information as well as any content associated with that account) as well as personal information we receive from you through the use of the Software:

- For the benefit of the business purposes of Barco and/or its affiliates;
- In order to provide, maintain, protect and/or improve the Software and to develop new software;
- For administration of the relationship between you, your organization and Barco and/or its affiliates ;
- For any other legitimate purpose (including i) direct marketing purposes from Barco, its affiliates or selected third parties, and ii) allowing third parties to provide services to you related to the Software);
- if required to do so by law or in a good faith belief that such access preservation or disclosure is reasonably necessary to:
 - Satisfy any applicable law, regulation, legal process or enforceable governmental request;
 - Enforce this Software License, including investigation of potential violations hereof;
 - Detect, prevent, or otherwise address fraud, security or technical issues (including, without limitation, the filtering of spam);
 - Protect against imminent harm to the rights, property or safety of Barco, its users or the public as required or permitted by law.

Barco shall not process any "sensitive information" whatsoever, including but not limited to medical information.

You understand that the technical processing and transmission of or by the Software, including your content, may involve:

- Transmissions over various networks;
- Changes to conform and adapt to technical requirements of connecting networks, devices and/or services.

You hereby explicitly give consent that Barco may export your personal data to any country worldwide, especially to any country where Barco and/or its affiliates have infrastructure, or where a third party is making available infrastructure to Barco and/or its affiliates, to process personal data.

Barco fully adheres to the EU Directive 95/46/EC on the protection of individuals with regard to the processing of personal data and the free movement of such data, as implemented in the local EU member states. In accordance with these regulations, you have a right of access to, and rectification of, your personal data. You may exercise these rights by contacting Barco.

Open Source Software provisions:

This product contains software components released under an Open Source license. A copy of the source code is available on request by contacting your Barco customer support representative.

EACH SEPARATE OPEN SOURCE SOFTWARE COMPONENT AND ANY RELATED DOCUMENTATION ARE PROVIDED "AS IS" WITHOUT EXPRESS OR IMPLIED WARRANTY INCLUDING, BUT NOT LIMITED TO, THE IMPLIED WARRANTIES OF MERCHANTABILITY AND FITNESS FOR A PARTICULAR PURPOSE. IN NO EVENT SHALL THE COPYRIGHTHOLDER OR ANY OTHER CONTRIBUTOR BE LIABLE FOR DIRECT, INCIDENTAL, SPECIAL, EXEMPLARY OR CONSEQUENTIAL DAMAGES, EVEN IF ADVISED OF THE POSSIBILITY OF SUCH DAMAGES, HOWEVER CAUSED AND ON ANY THEORY OF LIABILITY, WHETHER IN CONTRACT, STRICT LIABILITY, OR TORT (INCLUDING NEGLIGENCE OR OTHERWISE) ARISING IN ANY WAY OUT OF THE USE OF THIS OPEN SOURCE SOFTWARE. MORE INFORMATION/DETAILS IS TO BE FOUND IN EACH SPECIFIC OPEN SOURCE LICENSE.

Copyright on each Open Source Software component belongs to the respective initial copyright holder, each additional contributor and/or their respective assignee(s), as may be identified in the respective documentation, source code, README file, or otherwise. You shall not remove or obscure or otherwise alter the respective copyrights.

You acknowledge living up to the conditions of each separate Open Source Software license.

In the development of the Software, the following Open Source Software components have been used (an updated list may be made available through the (customer section of the) Barco website or other (online) means):

Open Source component	Open Source License
acl	http://www.gnu.org/licenses/old-licenses/gpl-2.0.html
acpid	http://www.gnu.org/licenses/gpl.html
attr	http://www.gnu.org/licenses/old-licenses/gpl-2.0.html
alsa-lib	http://www.gnu.org/licenses/gpl.html
	http://www.gnu.org/licenses/lgpl.html
alsa-utils	http://www.gnu.org/licenses/gpl.html
	http://www.gnu.org/licenses/lgpl.html

Open Source component	Open Source License
alsa-plugins	http://www.gnu.org/licenses/gpl.html
	http://www.gnu.org/licenses/lgpl.html
avahi	http://www.gnu.org/licenses/lgpl.html
Bootstrap (3.1.1)	https://github.com/twbs/bootstrap/blob/master/LICENSE
bootstrap-dialog	https://github.com/twbs/bootstrap/blob/master/LICENSE
bootstrap-slider.js v2.0.0	http://www.apache.org/licenses/LICENSE-2.0
busybox	http://opensource.org/licenses/GPL-2.0
Chart.js	https://github.com/nnnick/Chart.js/blob/master/LICENSE.md
Datepicker for Bootstrap (1,6,0-dev)	http://www.apache.org/licenses/LICENSE-2.0
dropbear	http://opensource.org/licenses/mit-license.php
fakeroot	http://www.gnu.org/licenses/gpl.html
coreutils	http://www.gnu.org/licenses/gpl.html
crda	http://opensource.org/licenses/ISC
cron	http://opensource.org/licenses/ISC
Crypto++	http://www.cryptopp.com/License.txt
dbus	http://www.gnu.org/licenses/old-licenses/gpl-2.0.html
dhcpcd	http://opensource.org/licenses/ISC
dm-crypt	http://creativecommons.org/licenses/by-sa/3.0/
dmidecode	http://www.gnu.org/licenses/old-licenses/gpl-2.0.html
e2fsprogs	http://www.gnu.org/licenses/old-licenses/lgpl-2.1.html
eglibc	http://www.gnu.org/licenses/lgpl.html
ethtool	http://www.gnu.org/licenses/gpl.html
express	http://opensource.org/licenses/MIT
FFmpeg	http://www.gnu.org/licenses/old-licenses/lgpl-2.1.html
freetype	http://freetype.sourceforge.net/FTL.TXT
	http://www.gnu.org/licenses/old-licenses/gpl-2.0.html
gdbserver	http://www.gnu.org/licenses/gpl.html
gmp	http://www.gnu.org/licenses/lgpl.html
grub	http://www.gnu.org/licenses/gpl.html
gststreamer	http://www.gnu.org/licenses/lgpl.html
hdparm	http://opensource.org/licenses/BSD-3-Clause
hostapd	http://opensource.org/licenses/BSD-3-Clause
HTML5 Shiv 3.7.2	http://github.com/aFarkas/html5shiv/blob/master/MIT%20and%20GPL2%20licenses.md
i18next (1.10.0)	https://opensource.org/licenses/MIT
i2c-tools	http://www.gnu.org/licenses/old-licenses/gpl-2.0.html
iftop	http://www.gnu.org/licenses/old-licenses/gpl-2.0.html
imx-bootlets	http://www.gnu.org/licenses/gpl.html
iperf	http://opensource.org/licenses/BSD-3-Clause
iproute2	http://www.gnu.org/licenses/gpl.html
iptables	http://www.gnu.org/licenses/old-licenses/gpl-2.0.html

Open Source component	Open Source License
iw	http://opensource.org/licenses/BSD-3-Clause
Jasny Bootstrap (3.1.3)	http://www.apache.org/licenses/LICENSE-2.0
jQuery Form Plugin (3.51.0-2014.06.20)	https://github.com/malsup/form#copyright-and-license
jQuery JavaScript Library (1.11.3)	https://jquery.org/license/
jQuery Password Strength plugin for Twitter Bootstrap	https://github.com/ablanco/jquery.pwstrength.bootstrap/blob/master/GPL-LICENSE.txt
	https://github.com/ablanco/jquery.pwstrength.bootstrap/commit/19480555e8c7c2f417d78a78dac63056fa221f6a
jQuery Upload File Plugin (4.0.8)	https://github.com/hayageek/jquery-upload-file
jQuery Validation Plugin (1.13.1)	https://opensource.org/licenses/MIT
kobs-ng	http://www.gnu.org/licenses/gpl.html
libarchive	http://opensource.org/licenses/bsd-license.php
libav	http://www.gnu.org/licenses/old-licenses/lgpl-2.1.html
libavutil	http://www.gnu.org/licenses/old-licenses/lgpl-2.1.html
libcap2	http://www.gnu.org/licenses/gpl.html
libdaemon0	http://www.gnu.org/licenses/old-licenses/lgpl-2.1.html
libdrm2	http://opensource.org/licenses/MIT
libexpat1	http://opensource.org/licenses/MIT
libfontconfig1	http://opensource.org/licenses/BSD-3-Clause
libfontenc1	http://opensource.org/licenses/BSD-3-Clause
libgcc1	http://www.gnu.org/licenses/gpl.html
libgcrypt11	http://www.gnu.org/licenses/gpl.html
	http://www.gnu.org/licenses/lgpl.html
	http://www.gnu.org/copyleft/fdl.html
libglib-2	http://www.gnu.org/licenses/old-licenses/lgpl-2.1.html
libgnutls26	http://www.gnu.org/licenses/lgpl.html
libgpg-error0	http://www.gnu.org/licenses/gpl.html
	http://www.gnu.org/licenses/lgpl.html
	http://www.gnu.org/copyleft/fdl.html
libjpeg-turbo	http://opensource.org/licenses/BSD-3-Clause
libjpeg8	BSD like licensee
libnl2	http://www.gnu.org/licenses/lgpl.html
libNotify	https://wiki.gnome.org/FoundationBoard/Resources/LicensingAgreement
libnss-mdns	http://www.gnu.org/licenses/gpl.html
libpam	http://www.gnu.org/licenses/old-licenses/gpl-2.0.html
libpcap	http://opensource.org/licenses/BSD-3-Clause
libpcre0	http://opensource.org/licenses/BSD-3-Clause
libpixman-1-0	http://changelogs.ubuntu.com/changelogs/pool/main/p/pixman/pixman_0.10.0-0ubuntu1/libpixman-1-0.copyright
libpng12-0	http://www.libpng.org/pub/png/src/libpng-LICENSE.txt
libpopt0	http://opensource.org/licenses/MIT
libresample	http://www.gnu.org/licenses/lgpl.html

Open Source component	Open Source License
libsm6	http://metadata.ftp-master.debian.org/changelogs/main/libs/libsm/libsm_1.2.2-1_copyright
libstdc++6	http://www.gnu.org/licenses/gpl.html
libswscale	http://www.gnu.org/licenses/old-licenses/lgpl-2.1.html
libtalloc2	http://www.gnu.org/licenses/lgpl.html
libusb	http://www.gnu.org/licenses/old-licenses/lgpl-2.1.html
libva	Copyright (c) 2011, Advanced Micro Devices, Inc. All rights reserved.
libX11	http://opensource.org/licenses/MIT
libXdamage	http://opensource.org/licenses/MIT
libXext	http://opensource.org/licenses/MIT
libXfixes	http://opensource.org/licenses/MIT
libXinerama	http://opensource.org/licenses/MIT
libxml2	http://opensource.org/licenses/MIT
libXrender	http://opensource.org/licenses/MIT
libXtst	http://opensource.org/licenses/MIT
libz1	Free license
lighttpd	http://opensource.org/licenses/BSD-3-Clause
linux	http://www.gnu.org/licenses/old-licenses/gpl-2.0.html
lmsensors	http://www.gnu.org/licenses/gpl.html
logrotate	http://www.gnu.org/licenses/gpl.html
makedevs	http://www.gnu.org/licenses/gpl.html
memtest86plus	http://www.gnu.org/licenses/gpl.html
mesa	http://opensource.org/licenses/MIT
modernizr (3.1.0)	https://opensource.org/licenses/MIT
module-init-tools	http://www.gnu.org/licenses/old-licenses/gpl-2.0.html
modutils	http://www.gnu.org/licenses/old-licenses/gpl-2.0.html
monit	http://www.gnu.org/licenses/gpl.html
ncurses	http://opensource.org/licenses/MIT
netbase	http://www.gnu.org/licenses/old-licenses/gpl-2.0.html
node.js	https://raw.githubusercontent.com/joyent/node/v0.10.26/LICENSE
openssl	http://www.openssl.org/source/license.html
openssh-sftp-server	http://opensource.org/licenses/BSD-3-Clause
opkg	http://www.gnu.org/licenses/old-licenses/gpl-2.0.html
passport	http://opensource.org/licenses/MIT
passport-http	http://opensource.org/licenses/MIT
pciutils	http://www.gnu.org/licenses/old-licenses/gpl-2.0.html
perl	http://perldoc.perl.org/perlartistic.html http://www.gnu.org/licenses/old-licenses/gpl-1.0.html
php	http://www.php.net/license/3_01.txt
procps	http://www.gnu.org/licenses/gpl.html
pulseaudio	http://www.gnu.org/licenses/lgpl.html

Open Source component	Open Source License
qt	http://doc.qt.io/qt-5/lgpl.html
read-edid	Free license
Respond.js	https://github.com/scottjehl/Respond/blob/master/LICENSE-MIT
rockbox-imxtools	http://www.gnu.org/licenses/old-licenses/gpl-2.0.html
rsync (<3.0.0)	http://www.gnu.org/licenses/old-licenses/gpl-2.0.html
rsync (>=3.0.0)	http://www.gnu.org/licenses/gpl.html
rsyslog	http://www.gnu.org/licenses/gpl.html
splashutils	http://www.gnu.org/licenses/gpl.html
sprintf-js	https://opensource.org/licenses/BSD-3-Clause
sscep	https://github.com/certnanny/sscep/blob/master/COPYRIGHT
strace	http://opensource.org/licenses/BSD-3-Clause
sysfsutils	http://www.gnu.org/licenses/old-licenses/gpl-2.0.html
sysvinit	http://www.gnu.org/licenses/old-licenses/gpl-2.0.html
tcpdump	http://opensource.org/licenses/BSD-3-Clause
Timepicker Component for Twitter Bootstrap	https://opensource.org/licenses/MIT
ttf-arphic-uming	http://ftp.gnu.org/non-gnu/chinese-fonts-truetype/LICENSE
ttf-dejavu-common	http://dejavu-fonts.org/wiki/License
ttf-dejavu-sans	http://dejavu-fonts.org/wiki/License
ttf-dejavu-sans-mono	http://dejavu-fonts.org/wiki/License
ttf-sazanami-gothic	https://osdn.jp/cvs/view/efont/sazanami/README http://metadata.ftp-master.debian.org/changelogs//main/t/ttf-sazanami/ttf-sazanami_20040629-8_copyright (translation)
ttf-sazanami-mincho	https://osdn.jp/cvs/view/efont/sazanami/README http://metadata.ftp-master.debian.org/changelogs//main/t/ttf-sazanami/ttf-sazanami_20040629-8_copyright (translation)
ttf-un-fonts	http://www.gnu.org/licenses/gpl.txt
u-boot	http://www.denx.de/wiki/U-Boot/Licensing
uClibc	http://www.gnu.org/licenses/lgpl.html
udev	http://www.gnu.org/licenses/old-licenses/gpl-2.0.html
update-modules	http://www.gnu.org/licenses/old-licenses/gpl-2.0.html
update-rc	http://www.gnu.org/licenses/old-licenses/gpl-2.0.html
usbutils	http://www.gnu.org/licenses/old-licenses/gpl-2.0.html
util-linux-ng	http://www.gnu.org/licenses/gpl.html
wireless_tools	http://www.gnu.org/licenses/gpl.html
wpa_supplicant	http://opensource.org/licenses/BSD-3-Clause
xserver-xorg	http://opensource.org/licenses/MIT
xvba-video	http://www.gnu.org/licenses/old-licenses/gpl-2.0.html
zeroconf	http://www.gnu.org/licenses/gpl.html

EN55022-CISPR22 Class B ITE (Information Technology Equipment)

This is a class B product. In a domestic environment this product may cause radio interference in which case the user may be required to take adequate measures.

If this equipment does cause interference to radio or television reception, the user may try to correct the interference by one or more of the following measures :

- Re-orientation of the receiving antenna for the radio or television.
- Relocate the equipment with respect to the receiver.
- Plug the equipment into a different outlet so that the equipment and receiver are on different branch circuits.
- Fasten cables connectors to the equipment by mounting screws.

Federal Communication Commission Interference Statement

You are cautioned that changes or modifications not expressly approved by the part responsible for compliance could void the user's authority to operate the equipment.

This equipment has been tested and found to comply with the limits for a Class B digital device, pursuant to Part 15 of the FCC rules. These limits are designed to provide reasonable protection against harmful interference in a residential installation. This equipment generates, uses and can radiate radio frequency energy and, if not installed and used in accordance with the instructions, may cause harmful interference to radio communications. However, there is no guarantee that interference will not occur in a particular installation.

If this equipment does cause harmful interference to radio or television reception, which can be determined by turning the equipment off and on, the user is encouraged to try to correct the interference by one or more of the following measures:

- Reorient or relocate the receiving antenna.
- Increase the separation between the equipment and receiver.
- Connect the equipment into an outlet on a circuit different from that to which the receiver is connected.
- Consult the dealer or an experienced radio/TV technician for help.

You may also find helpful the following booklet, prepared by the FCC: "How to Identify and Resolve Radio-TV Interference Problems." This booklet is available from the U.S. Government Printing Office, Washington D.C. 20402.

Changes and Modifications not expressly approved by the manufacturer or registrant of this equipment can void your authority to operate this equipment under Federal Communications Commissions rules.

In order to maintain compliance with FCC regulations shielded cables must be used with this equipment. Operation with non-approved equipment or unshielded cables is likely to result in interference to radio & television reception.

FCC RF Radiation Exposure Statement: This device is capable of operating in 802.11a mode. For 802.11a devices operating in the frequency range of 5.15 - 5.25 GHz, they are restricted for indoor operations to reduce any potential harmful interference for Mobile Satellite Services (MSS) in the US. WIFI Access Points that are capable of allowing your device to operate in 802.11a mode (5.15 - 5.25 GHz band) are optimized for indoor use only. If your WIFI network is capable of operating in this mode, please restrict your WIFI use indoors to not violate federal regulations to protect Mobile Satellite Services.

Base Unit FCC ID: 2AAED-R9861520

Button FCC ID (model R9861006D01): XF6-RS9110N1103

Button FCC ID (model R9861500D01): 2AAED-R9861500D01

ClickShare Button R9861500D01 has been tested and meets the FCC RF exposure guidelines. The maximum SAR value reported is 0.915W/kg.

Canada, Industry Canada (IC) Notices

This device complies with Industry Canada licence-exempt RSS standard(s). Operation is subject to the following two conditions: (1) this device may not cause interference, and (2) this device must accept any interference, including interference that may cause undesired operation of the device.

Radio Frequency (RF) Exposure Information

The radiated output power of the Barco Wireless Device is below the Industry Canada (IC) radio frequency exposure limits. The Barco Wireless Device should be used in such a manner such that the potential for human contact during normal operation is minimized.

Base Unit IC ID: IC: 9393B-R9861520

Button IC ID (model R9861006D01): 8407A-RS9110N1103

Button IC ID (model R9861500D01): 9393B-R9861500D01

IC Antenna statement

Under Industry Canada regulations, this radio transmitter may only operate using an antenna of a type and maximum (or lesser) gain approved for the transmitter by Industry Canada. To reduce potential radio interference to other users, the antenna type and its gain should be so chosen that the equivalent isotropically radiated power (e.i.r.p.) is not more than that necessary for successful communication.

This radio transmitter 9393B-R9861520 has been approved by Industry Canada to operate with the antenna types listed below with the maximum permissible gain and required antenna impedance for each antenna type indicated. Antenna types not included in this list, having a gain greater than the maximum gain indicated for that type, are strictly prohibited for use with this device.

Type: Dipole

Maximum Peak Gain: 2 dBi

Impedance: 50 Ohm

Canada, avis d'Industry Canada (IC)

Le présent appareil est conforme aux CNR d'Industrie Canada applicables aux appareils radio exempts de licence. L'exploitation est autorisée aux deux conditions suivantes : (1) l'appareil ne doit pas produire de brouillage, et (2) l'utilisateur de l'appareil doit accepter tout brouillage radioélectrique subi, même si le brouillage est susceptible d'en compromettre le fonctionnement.

Informations concernant l'exposition aux fréquences radio (RF)

La puissance de sortie émise par l'appareil de sans fil Barco est inférieure à la limite d'exposition aux fréquences radio d'Industry Canada (IC). Utilisez l'appareil de sans fil Barco de façon à minimiser les contacts humains lors du fonctionnement normal.

IC ID Unité de Base: 9393B-R9861520

IC ID Button (modèle R9861006D01): 8407A-RS9110N1103

IC ID Button (modèle R9861500D01): 9393B-R9861500D01

Déclaration d'antenne d'Industrie Canada (IC)

Conformément à la réglementation d'Industrie Canada, le présent émetteur radio peut fonctionner avec une antenne d'un type et d'un gain maximal (ou inférieur) approuvé pour l'émetteur par Industrie Canada. Dans le but de réduire les risques de brouillage radioélectrique à l'intention des autres utilisateurs, il faut choisir le type d'antenne et son gain de sorte que la puissance isotrope rayonnée équivalente (p.i.r.e.) ne dépasse pas l'intensité nécessaire à l'établissement d'une communication satisfaisante.

Le présent émetteur radio 9393B-R9861520 a été approuvé par Industrie Canada pour fonctionner avec les types d'antenne énumérés ci-dessous et ayant un gain admissible maximal et l'impédance requise pour chaque type d'antenne. Les types d'antenne non inclus dans cette liste, ou dont le gain est supérieur au gain maximal indiqué, sont strictement interdits pour l'exploitation de l'émetteur.

Type: Dipole

Gain maximum: 2 dBi

Impédance: 50 Ohm

TABLE OF CONTENTS

1. Introduction	3
1.1 Versions of the product	3
1.2 About this guide	3
1.3 Symbols and fonts	4
2. Introduction to CSE-200	5
2.1 About the CSE-200	5
2.2 About the Base Unit	6
2.3 About the Button	7
2.4 Mobile Device Support	8
3. Getting started	9
3.1 Activating the base unit	9
3.2 Basic Use	9
3.3 User Interface	11
3.4 Capture more	12
3.5 Shared desktop: primary - extended	13
3.6 Audio configuration	15
3.7 Pairing	17
4. Troubleshooting	19
4.1 Basic Troubleshooting	19
5. Environmental information	21
5.1 Disposal information	21
5.2 Rohs compliance	21
5.3 Production address	22
5.4 Importers contact information	22

1. INTRODUCTION

Overview

- Versions of the product
- About this guide
- Symbols and fonts

1.1 Versions of the product

Regional versions

Depending on the location where you buy the CSE-200 product, the Base Unit and accessories are regionalized. By the time of release of this manual, 3 regional versions of CSE-200 are available:

- Europe & Japan
- North America
- China



The regional version of your CSE-200 cannot be changed. That means that you cannot use it in another region.

For more information on the regional variants, refer to the CSE-200 Installation Guide.

1.2 About this guide

This manual

Partnumber	Description	Level
R5900025	User Guide	User

Available System documentation

This guide is part of the documentation set describing the CSE-200 product.

Guide	Article number
User Guide	R5900025
Installation Guide	R5900023
Safety Guide	R5900032
Service Guide	R5900027
Button Guide	R5900007
Recycling Manual	R5900029
API Guide	R5900018

A printed copy of the Safety Guide and an electronic version on USB stick of the user and installation guide is included in the CSE-200 box at purchase.



Always check for the latest version of the manual on www.barco.com/clickshare Click on Visit the ClickShare product page and go to tab Downloads..







Depending on the CSE-200 version, some graphics might be different to the ones used in this manual. This however does not have any effect to the functionality.

The User Guide describes how to use your CSE-200. It also contains a basic troubleshooting part where you can search for a solution when a problem occurs.

1.3 Symbols and fonts

Symbol overview

The following icons are used in the manual :

	Caution
	Warning
	Info, term definition. General info about the term
	Note: gives extra information about the described subject
	Tip: gives extra advice about the described subject

Font overview

- Buttons are indicated in bold, e.g. **OK**.
- Menu items are indicated in *italic*.
- Step related notes, tips, warnings or cautions are printed in *italic*.
- Procedure related notes, tips, warnings or cautions are printed in **bold** between 2 lines preceded by the corresponding icon.

2. INTRODUCTION TO CSE-200

Overview

- About the CSE-200
- About the Base Unit
- About the Button
- Mobile Device Support

2.1 About the CSE-200

CSE-200 sets

CSE-200 makes connecting to the meeting room's video system a matter of clicking a Button. This CSE-200 not only helps the presenter get the presentation on-screen in a second, but it also allows the other people in the meeting to participate more actively. The result is enhanced meeting efficiency and better decision-making.

At the moment 3 different sets are available on the market. Each set is sold in its specific region and it can only be used in that specific region because of WiFi regulations.

Components CSE-200 set

A standard CSE-200 set consists of a Base Unit and 2 Buttons. Depending on the location where you buy the product, the software of the Base Unit is different. If needed, you can buy additional Buttons and a tray to store the buttons.

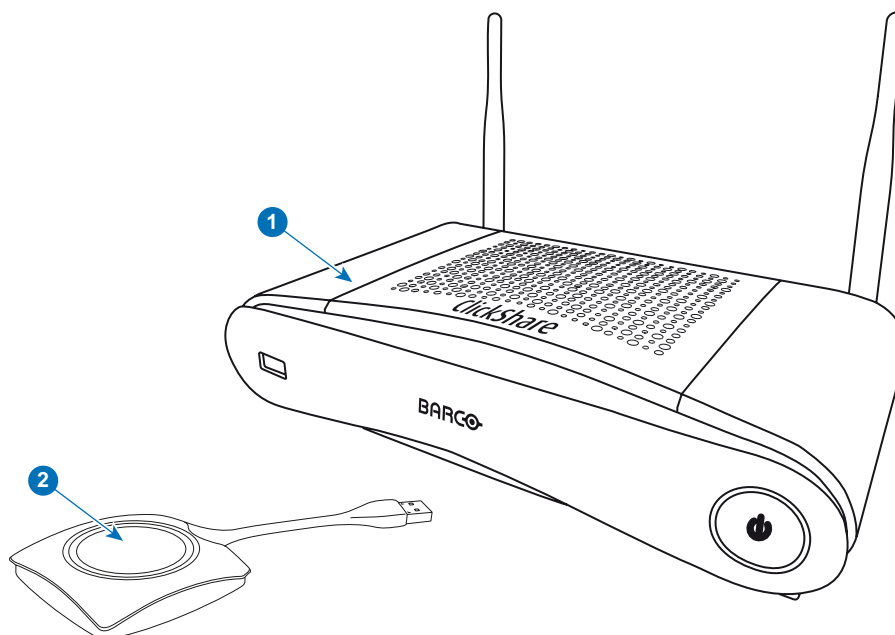

Image 2-1

- | | |
|---|-----------|
| 1 | Base unit |
| 2 | Button |

Accessories included

Depending on the country where you buy the product, the following regionalized accessories are also included in the CSE-200 box.

Regional version	Contains	Accessories included
R9861520xx ¹	<ul style="list-style-type: none"> R9861520 2x R9861500D01 	<ul style="list-style-type: none"> DC adapter with AC clips type A, C, G, I USB stick with user documentation 2 antennas Printed safety manual

Contact your local sales representative for the correct regional variant to be used in your country.

2.2 About the Base Unit

Base Unit functionality

The Base Unit receives the wireless input from the Buttons and controls the content of the meeting room display and the sound of the meeting room's audio system.

The Base Unit can be inside a cabinet in the meeting room, or put on the meeting room table or mounted on a wall. Check the Installation Guide for instructions on how to install the Base Unit.

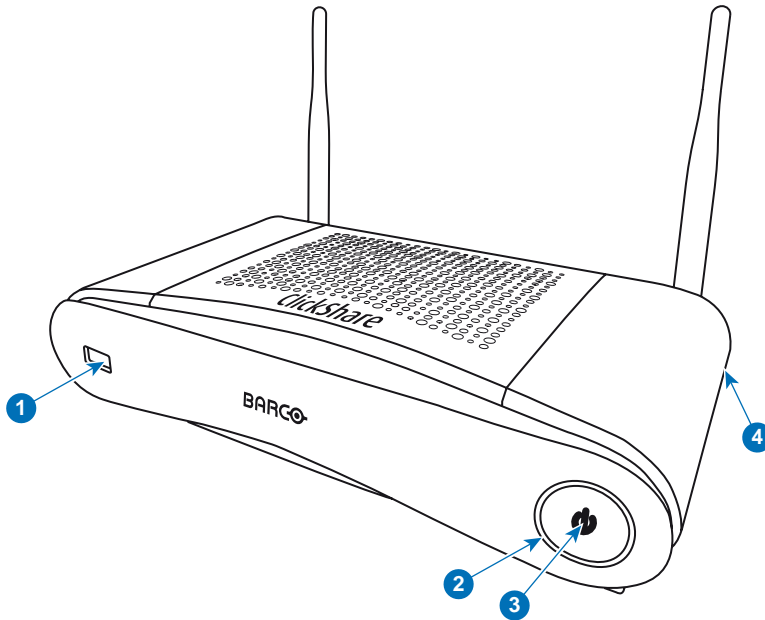

Image 2-2

1	USB port
2	Status LED ring
3	Power Button
4	Kensington lock

Table 2-3

USB Port

The USB port is used to update the software of both the Base Unit and the Buttons.

When plugging in the Button into the Base Unit, the Button is paired to the Base Unit. The Base Unit checks whether the software and firmware of the Button is up to date. If not, the Base Unit updates the software and/or firmware.

Status LED ring

The color of the LED ring around the power button of the Base Unit give information on the status of the system.

1. xx=EU, CN, NA,

LEDs behavior	Explanation
static red	<ul style="list-style-type: none"> receiving content from the Buttons and streaming towards the display. pairing and software update of the Button is done. You can now unplug the Button from the Base Unit. during the first phase of the Base Unit boot process.
blinking white	<ul style="list-style-type: none"> system is starting up (during the second phase) Button pairing is in progress software update of the Base Unit
breathing white	<ul style="list-style-type: none"> ECO standby mode
static white	<ul style="list-style-type: none"> awake and ready (i.e. showing the welcome message on the display) pairing is done
red blinking	<ul style="list-style-type: none"> an error occurred
dark	<ul style="list-style-type: none"> deep standby/off

Power button

The button at the front of the Base Unit has a power on/off function once the Base unit is powered.

- When the system is powered on, a push makes the system to shut down and power off.
- When the system is shut down, a push triggers the system to start up.

2.3 About the Button

Button functionality

A Button contains three main functional components.

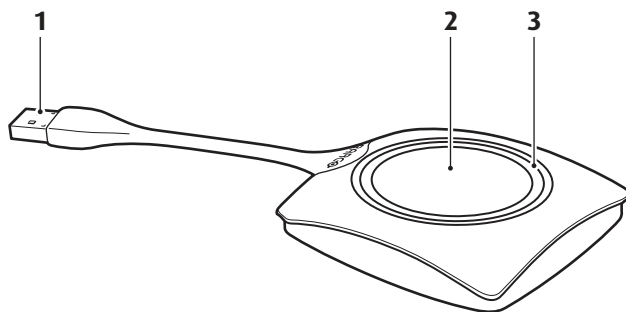

Image 2-3
The Button

1	USB connector
2	Button
3	LED ring

Table 2-5



Handle the Button cable with care. Rough handling might cause defects.

USB connector

Using the USB connector the Button can be plugged into a laptop (for sharing your screen) or in the Base Unit (for pairing the Button to the Unit or updating its software).

Button

Click the Button to display the content of the laptop's screen on the meeting room display. Clicking the Button during the meeting will toggle the sharing of the screen.

LED ring

The LED ring indicates the current status of your CSE-200.

LEDs behavior	Explanation
white blinking	<ul style="list-style-type: none"> the Button is plugged in the laptop and initializing or waiting for the user to start the ClickShare application. pairing/software update of the Button in the Base Unit is in progress.
static white	<ul style="list-style-type: none"> ClickShare is ready to start sharing your screen. pairing is done. You can now unplug the Button from the Base Unit.
static red	<ul style="list-style-type: none"> sharing your screen with the display. pairing and software update is done. You can now unplug the Button from the Base Unit.
red blinking	<ul style="list-style-type: none"> an error occurred.
off (no light)	<ul style="list-style-type: none"> the Button is not or not properly inserted into the USB port. the Button might be defective. the USB port or computer might be defective.

2.4 Mobile Device Support

Overview

The below list of Apps are supported by ClickShare and can be installed on your mobile device from Google Play or Apple App Store.

Before you can use your mobile device with ClickShare, you have to connect the mobile device Wi-Fi with the ClickShare Base Unit Wi-Fi. Follow the instructions as given in your mobile device user guide.

App	Used on	Logo
ClickShare App	iOS Android	

3. GETTING STARTED

Overview

- Activating the base unit
- Basic Use
- User Interface
- Capture more
- Shared desktop: primary - extended
- Audio configuration
- Pairing

3.1 Activating the base unit

About power mode

The Base Unit is powered via an external power adapter. Once connected, the Base Unit is automatically switched in standby mode. For more information about power connection, see CSE-200's installation manual.

On and off

1. Push the button shortly.

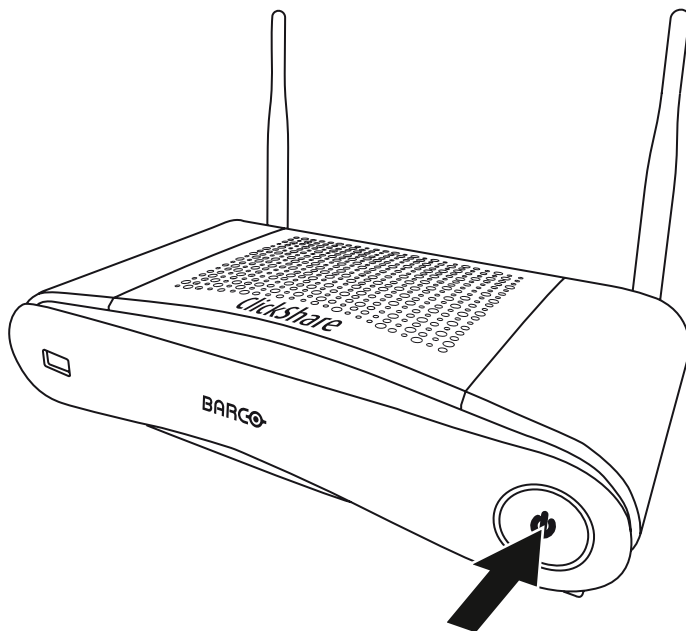

Image 3-1
Standby button

When the Base Unit was on, it goes out

When the Base Unit was off, it starts up.

3.2 Basic Use

Basic functionality

When entering a meeting room equipped with ClickShare and if the display is not in screensaver mode, the ClickShare wallpaper is shown on the display. The content of the wallpaper depends on the setup.

Starting to use ClickShare is now very simple.

To start using ClickShare

1. Take a Button and Insert the Button into a USB port of your laptop.

3. Getting started

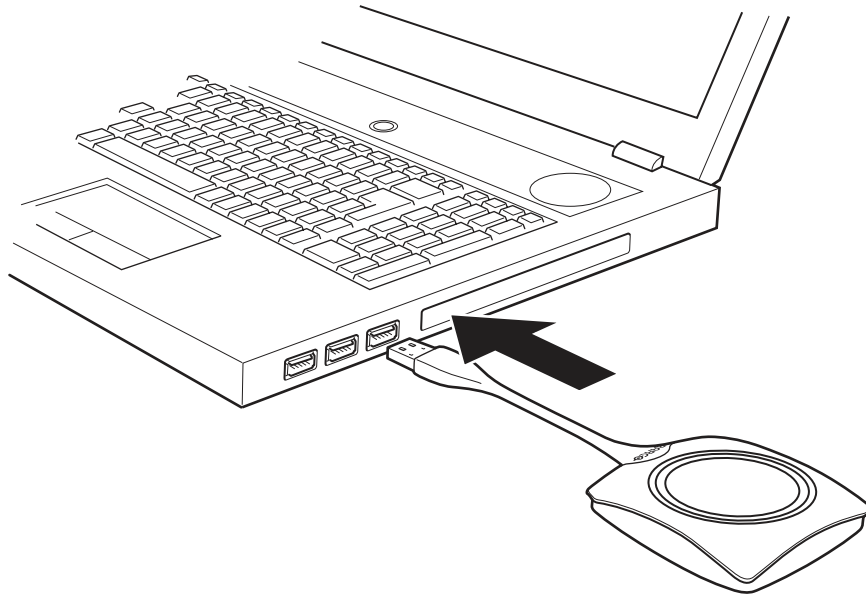

Image 3-2

The LEDs of the Button start flashing white.

On your laptop a new drive appears.

Two situations are possible now:

- A launcher is preinstalled on your laptop (downloaded from the Base Unit or Barco website, or deployed company-wide by your IT department). ClickShare is immediately available. You can continue with step 4.
- nothing is pre-installed. Continue with step 2.

2. Browse to and double-click the ClickShare drive on your laptop.

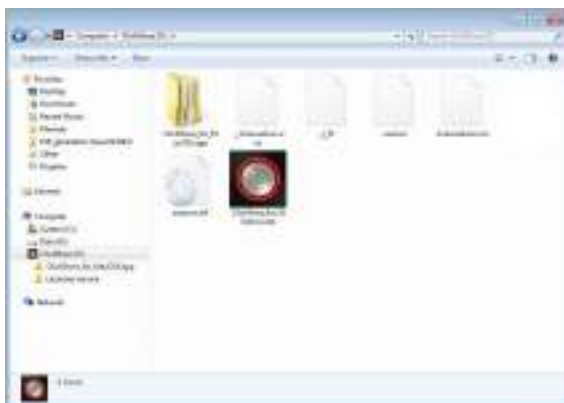

Image 3-3
Windows environment



Image 3-4
MAC environment

3. Double-click the ClickShare application.



The ClickShare client software starts and its icon appears in the system tray.

On a Windows computer: 

On a Macintosh: 

When the system is ready for use, a message appears close to the systray icon.

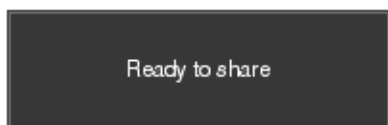



Image 3-5

The LEDs of the Button are static white.

- To share your screen on the display, click the Button.

The LEDs of the Button become static red and your screen appears on the display. When audio is enabled on the ClickShare Base Unit, the audio of your laptop is also available on the audio output of the Base Unit and on the HDMI output, and it will be played via the meeting room audio system. The icon returns to the same state as in step 3.

In the system tray, the ClickShare icon starts rotating. On Windows computers the icon changes into .

The name of the user logged on to the laptop which is sharing its content is briefly shown in the bottom left corner of the added content.

ClickShare automatically scales the content of your screen to the resolution of the meeting room display. The aspect ratio of your screen is maintained to make sure the proportions are correct.

- To remove your content from the display, click the Button again.

The LEDs of the Button become static white.

- When leaving the meeting room, unplug the Button from your laptop.

No trace of the ClickShare application is left on your laptop.

3.3 User Interface

User Interface functionality

After launching the client, the ClickShare icon appears in the system tray.

ClickShare context menu

The content of the context menu is related to the operating system.

- Right-click the ClickShare icon in the system tray.

The context menu appears.



Image 3-6
Context menu

- From the list, click the action you want to perform.

3. Getting started

Click	To	Result
Start sharing	to show your screen on the display.	The LEDs of your Button become red.
Show me fullscreen	to bring the content of your screen on the display full screen.	The screens of other users that were shown on the display disappear.
Settings...	select the way to connect. Via ClickShare Button or via a network connection	Connected via Button or via network
Pair Button	to pair the connected Button with the Base Unit	Button is ready for use.
Capture mode	to choose to capture video with more (slower performance) or less detail (faster performance).	Tune video performance and quality
Shared desktop (only for Windows7 and Windows8)	to select primary or extended desktop	Depending on the selection the primary or the extended display is displayed.
About ClickShare Client	to find out the ClickShare software version.	Here you can find more information on the ClickShare software version.
Exit	to close ClickShare.	The ClickShare icon disappears from the system tray and the LEDs of the Button start blinking white.

3.4 Capture more



Only for Windows XP, Windows Vista and Windows 7 & 8.

About capture more

ClickShare is optimized for optimum video performance. Upon starting the client software it will disable Win7 Aero Glass to maximize video performance. Upon quitting the ClickShare applications your Aero Glass settings will be restored.

Transparent alpha layers are by default not captured. Therefore some windows may not be shown or may appear different on screen. For example content of video players using overlays will not be shown.

With "Capture More" selected, Win7 Aero Glass settings will be restored and capturing of alpha layers is enabled. In this mode, video throughput may decrease a bit and more details will be captured.

Default setting: Not checked.

How to change

1. Right click on the ClickShare icon in the system tray (1).



Image 3-7
Change capture mode

A context menu opens.

2. Click *Capture More* to toggle.

Checked: capture with more details but may have a lower performance.

Not checked: capture will be faster but may lose some of the details

Starting the client automatically in Capture More

The Capture more mode can be started by default so that the Aero Glass settings are not disabled. To do so, an environment variable should be introduced in your windows. Ask you administrator or consult your windows documentation to find out how to create.

The following variable should be introduced :

Variable	Value
CLICKSHARE_CAPTUREMOREBYDEFAULT	1

3.5 Shared desktop: primary - extended



Only for Window7 and Windows8

About shared desktop

Depending on your selection, your primary screen or your extended screen will be captured and displayed via ClickShare. That extended screen can be a physical screen or a virtual screen.

With extended desktop you can take advantage of both your laptop screen and the central meeting room display. Presentation notes or other material on primary screen will not be displayed to everyone.

PC with virtual extended screen:



Image 3-8

Primary screen displayed on the PC, extended screen displayed on the meeting room display.



Image 3-9

PC with one extended screen connected. That extended screen will be captured and displayed on the meeting room display.

3. Getting started



Image 3-10

PC with two extended screens connected. The first extended screen, screen 2 will always be captured and displayed on the meeting room display.



To know if your system supports the extended desk top feature, press **Window key + P**. It should bring up the following pop-up on screen:



Image 3-11

How to select

1. Right click on the ClickShare icon in the system tray (1).

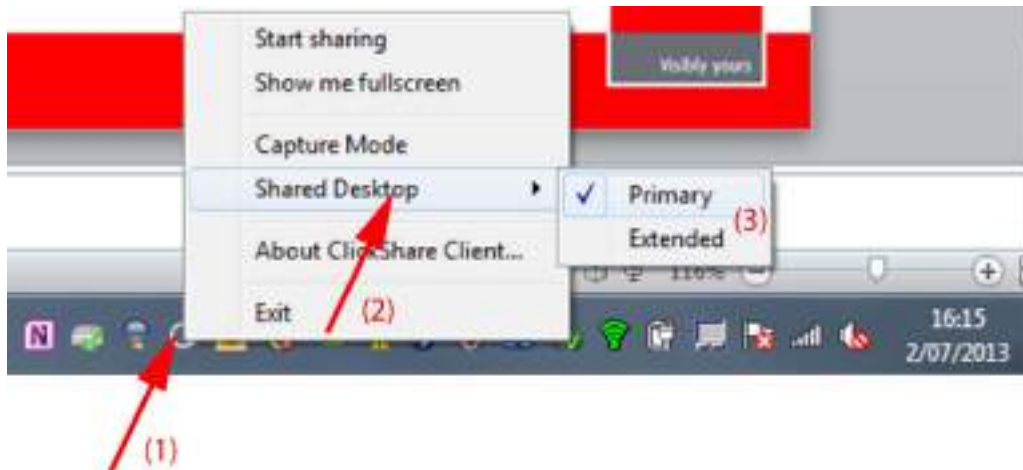

Image 3-12
Shared desktop selection

A context menu opens.

2. Select *Shared Desktop* (2).
3. Select the desired setting (3).

Primary : the primary PC screen is displayed on the meeting room display.

Extended always the secondary screen is displayed on the meeting room display.

Known issue

- Virtual Extended Desktop not supported on some Windows7 and Windows8 systems due to a problem in recent versions of the AMD graphical driver. Downgrade to an older version of the driver might resolve the issue but make sure the AMD driver updated above version 13.8 .

3.6 Audio configuration

Audio configuration

The connected user must control his own audio signal using the audio configuration of his computer. If he does not want to broadcast his audio signal, he has to mute audio on his computer.

For some operating system, it is necessary to set ClickShare as your default output device. Once you unplug the Button, the default setting is switched back to the previous setting.

Set ClickShare as default in Windows 7

1. Right click on the speaker icon in the system tray (1).

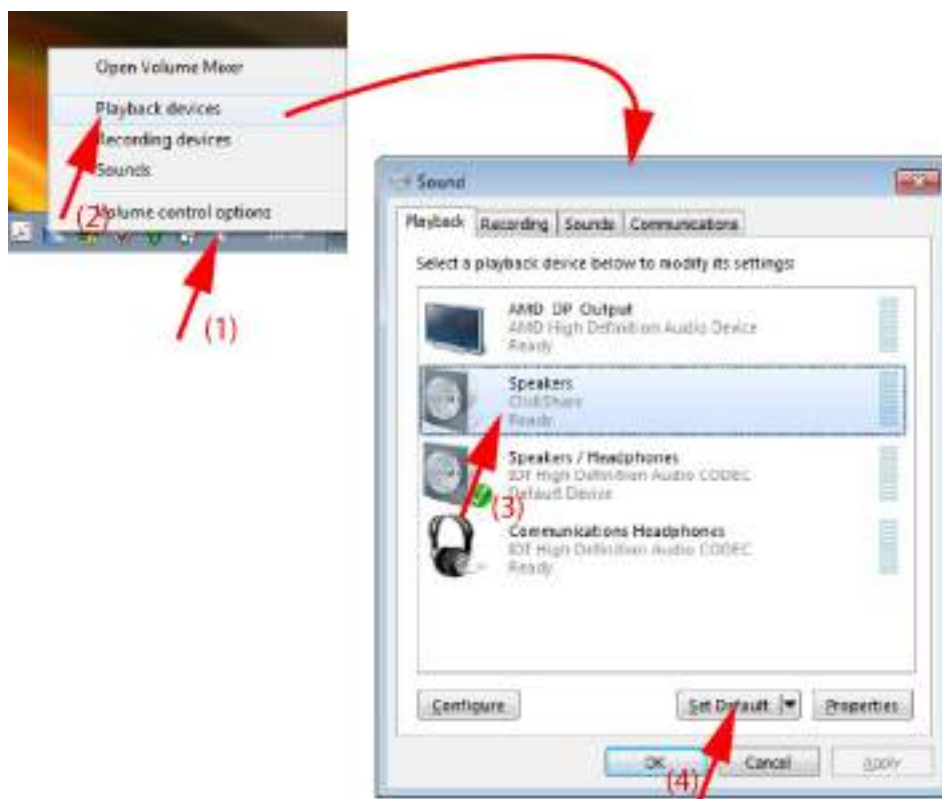

Image 3-13
Speakers ClickShare, default

2. Click *Playback devices* (2).

The *Sound* window opens on the *Playback* tab.

3. Select *Speakers ClickShare* (3) and click *Set default* (4).
4. Click **Apply** or **OK** to activate the new setting.

Set ClickShare as default in Windows XP

1. Right click on the speaker icon in the system tray.

3. Getting started

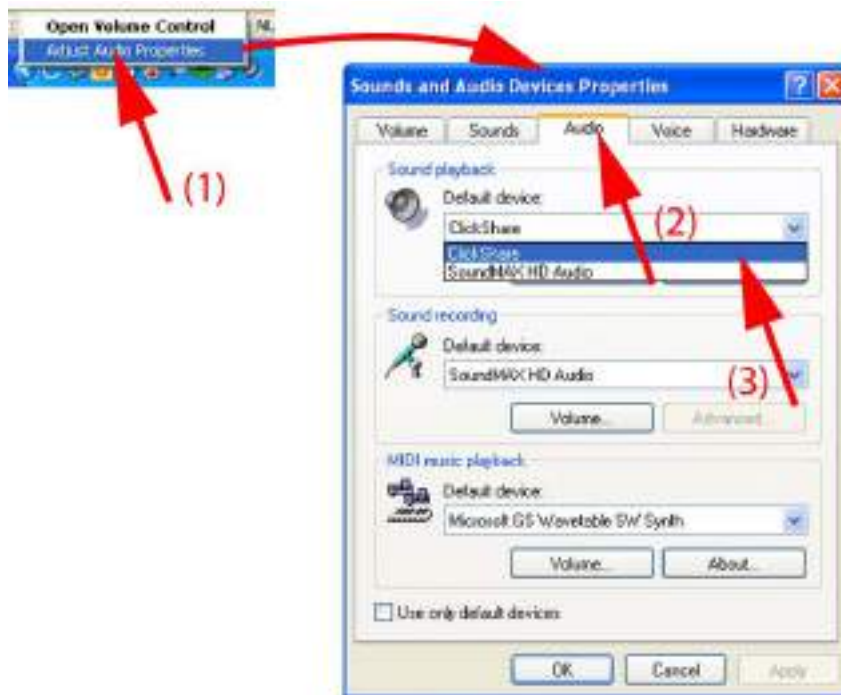

Image 3-14
Speakers ClickShare, default

2. Click *Adjust Audio Properties* (1).

The *Sound and Audio Devices Properties* window opens.

3. Select **Audio** tab (2).
4. Click on the drop down box in the *Sound playback* pane and select ClickShare (3)..
5. Click **Apply** or **OK** to activate the new setting.

Set ClickShare as default on MAC

1. Click on the Apple logo on the menu bar (1) and select *System Preferences...* (2).

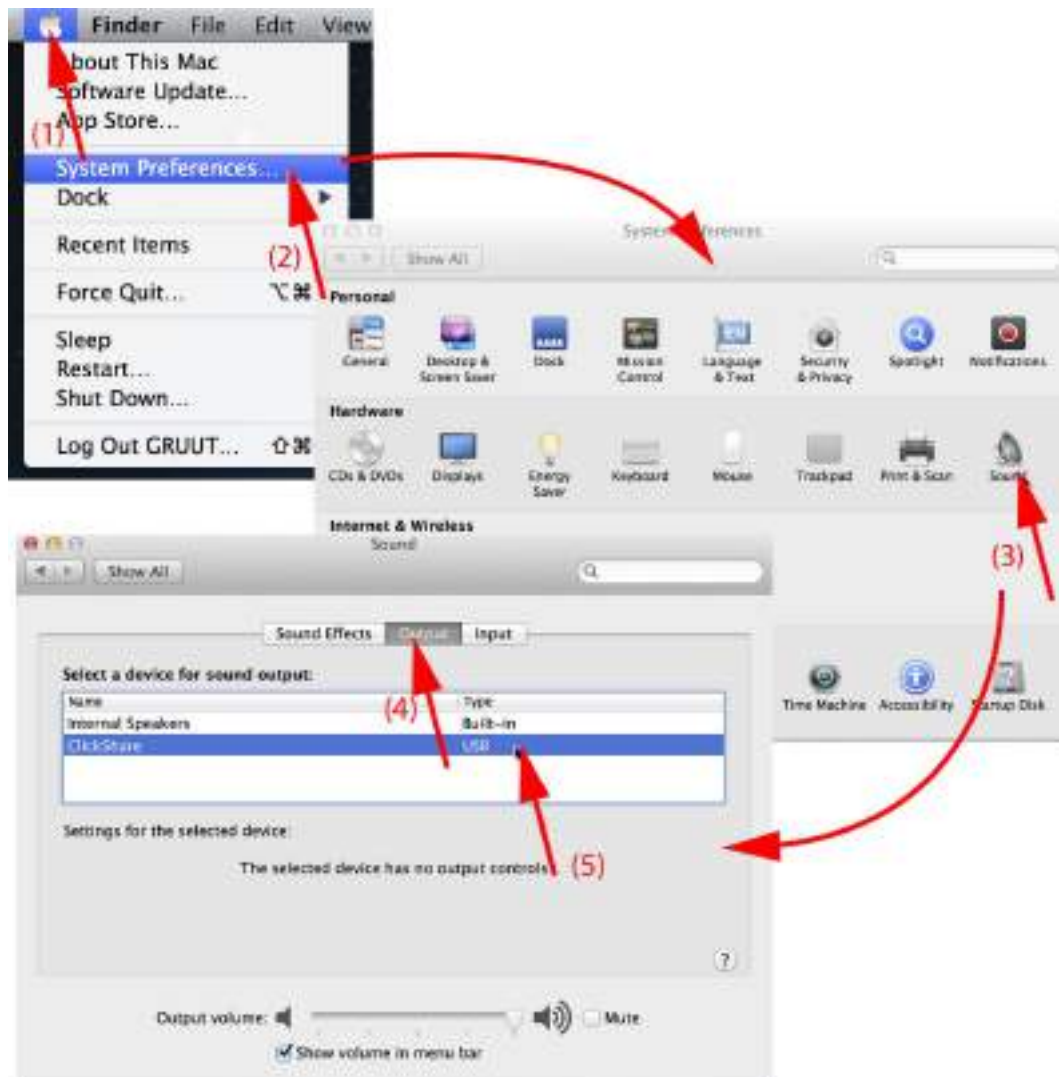

Image 3-15
Speakers ClickShare, default

2. Click on the *Speaker* icon (3).
The *Sound* window opens.
3. Select the *Output* tab (4) and activate ClickShare (5).

3.7 Pairing

Pairing of the Buttons with the Base Unit

To be able to use a Button it should be assigned to the Base Unit you are using. This process is called pairing. By default, the two Buttons delivered with the CSE-200 set are already paired to the specific Base Unit.

In case you buy additional Buttons or when a Button should be assigned to another Base Unit, the Button needs to be paired (again). The Button software update runs in the background and will not impact users while using the system. If desired, this feature can be disabled in the Web Interface. When downgrading or updating to an older version of the Base Unit software the Buttons need to be paired manually to update their software.



A Button can only be paired to one Base Unit at a time.

The Button will always make connection to the Base Unit it was last paired to.

To pair a Button to the Base unit

1. Insert the Button in the USB port at the front of the Base Unit you are using.

3. Getting started

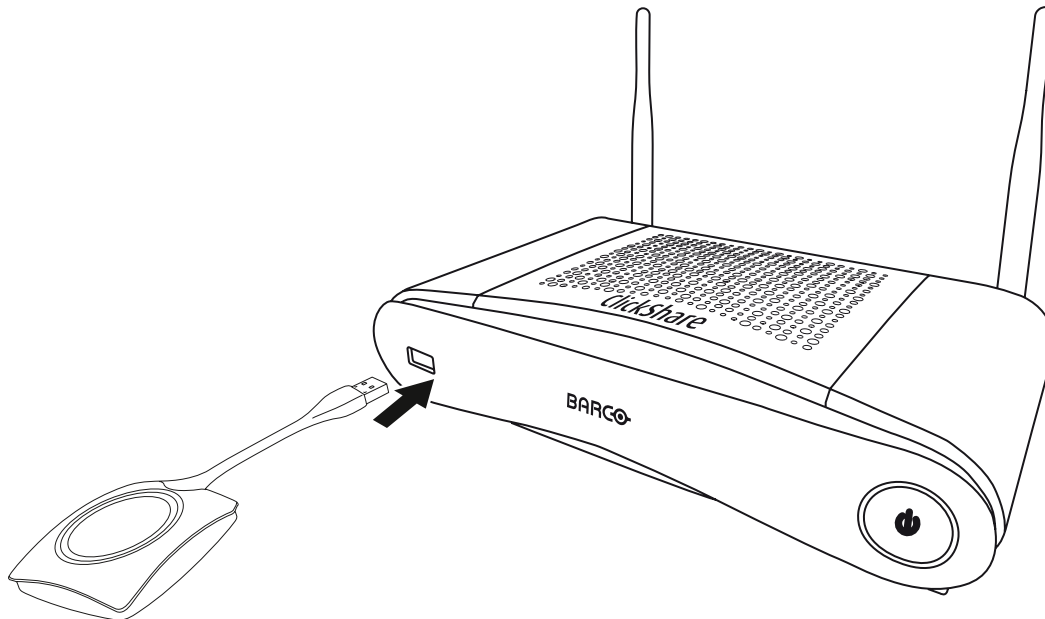

Image 3-16
Pair button

Both the LEDs of the Button and the LEDs of the Base Unit are blinking white. This means pairing is in progress.

The Base Unit automatically checks whether the software of the Button is up to date. If not, the Base Unit updates the Button software. This may take more time.

During the pairing and update process, a small status bar is display.

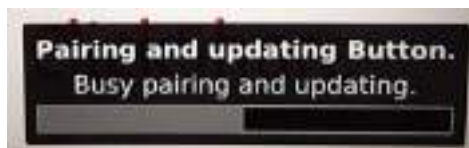

Image 3-17
Pairing message

The result of the pairing process can be as follows:

- When the LEDs become static white, the Button is paired to the Base Unit, but no software update was needed. You can unplug the Button from the Base Unit.
- When the LEDs become static red, the Button is paired to the Base Unit and the software update has finished. You can unplug the Button from the Base Unit.

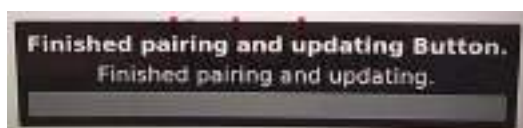

Image 3-18
Pairing finished

2. Unplug the Button from the Base Unit.

The Button is now ready for use.

4. TROUBLESHOOTING

4.1 Basic Troubleshooting

Problem solving

In this chapter some problems that might occur while using CSE-200 are listed. For each problem possible causes are given and a solution is proposed. If you cannot solve the problem yourself, please contact your local IT administrator.

Problem	Cause	Solution
Your screen is not shown on the display when pressing the Button.	You are the third person that wants to share the content to the display.	The first or second user has to push his button to remove his content so that a third user can share his content. or As third user, click and hold the Button to use the Show me function of ClickShare.
	The ClickShare client software is not running.	Go to the ClickShare drive and run the software.
Your screen is shown, but your audio is not playing on the meeting room audio system	Your audio signal on your PC is muted	Right click on the speaker icon and switch off the mute.
	Audio system of the meeting room is not switched on	Switch on the audio system of the meeting room.
	When using separate audio, audio cable is not connected	Check audio connection between the Base Unit (audio out, green connector) and the audio system of the meeting room.
	Default speaker is not correctly set .	With a Button inserted, set ClickShare speaker as your default speaker.
	Buttons are not re-paired after changing the audio setting on the web interface	Re-pair the buttons.
Your content is removed from the display and the LEDs of your Button are blinking white.	Audio setting on the web interface is not correctly set.	Consult your administrator to select the correct audio setting.
	Connection to the display has been lost.	ClickShare tries to restore the connection automatically. If this fails, the LEDs of the Button start blinking red. You should unplug the Button from your laptop and start a new.
Nothing is shown on the display at all.	The display is switched off.	Switch on the display.
	Wrong input is selected.	Select the correct input.
	The display cable is not connected (correctly).	(Re)insert the display cable to the display and the Base Unit.
	The display does not recognize or is not able to display the Base Unit output resolution.	You or an administrator should change the corresponding setting via the web interface.
	The Base Unit is in standby mode.	Briefly push the standby button on the Base Unit or plug in a Button and run the ClickShare client software.
	The Base Unit is powered off.	Check if power adapter is connected to the Base unit and to the wall outlet.
	The Button's software is not compatible with that of the Base unit	Re-pair and update the software of the Button by inserting it in the front USB port of Base Unit.

4. Troubleshooting

Problem	Cause	Solution
After inserting the Button into your laptop, you cannot find the ClickShare drive.	No automatic refresh of drives.	Refresh the view on your laptop.
	Bad connection at USB port on laptop.	<ul style="list-style-type: none">• Reconnect to the USB port.• Try another USB port.• Reboot your laptop.
Some programs of Windows are not shown on the display.	Windows tries to assign the ClickShare drive to an already reserved drive letter	Use Microsoft Windows Disk Management to assign it to a free drive letter.
	Use of overlays, 3D or hardware acceleration in the GPU.	<ul style="list-style-type: none">• Disable overlays or hardware acceleration in the GPU.• Disable AeroGlass in Windows 7• Capture mode

5. ENVIRONMENTAL INFORMATION

5.1 Disposal information

Disposal Information

Waste Electrical and Electronic Equipment



This symbol on the product indicates that, under the European Directive 2012/19/EU governing waste from electrical and electronic equipment, this product must not be disposed of with other municipal waste. Please dispose of your waste equipment by handing it over to a designated collection point for the recycling of waste electrical and electronic equipment. To prevent possible harm to the environment or human health from uncontrolled waste disposal, please separate these items from other types of waste and recycle them responsibly to promote the sustainable reuse of material resources.

For more information about recycling of this product, please contact your local city office or your municipal waste disposal service.

For details, please visit the Barco website at: <http://www.barco.com/en/AboutBarco/weee>

Disposal of batteries in the product



This product contains batteries covered by the Directive 2006/66/EC which must be collected and disposed of separately from municipal waste.

If the battery contains more than the specified values of lead (Pb), mercury (Hg) or cadmium (Cd), these chemical symbols will appear below the crossed-out wheeled bin symbol.

By participating in separate collection of batteries, you will help to ensure proper disposal and to prevent potential negative effects on the environment and human health.

5.2 Rohs compliance

Turkey RoHS compliance



Türkiye Cumhuriyeti: AEEE Yönetmeliğine Uygundur.

[Republic of Turkey: In conformity with the WEEE Regulation]

中国大陆 RoHS – Chinese Mainland RoHS

根据中国大陆《电子信息产品污染控制管理办法》(也称为中国大陆RoHS), 以下部分列出了Barco产品中可能包含的有毒和/或有害物质的名称和含量。中国大陆RoHS指令包含在中国信息产业部MCV标准:“电子信息产品中有毒物质的限量要求”中。

According to the “China Administration on Control of Pollution Caused by Electronic Information Products” (Also called RoHS of Chinese Mainland), the table below lists the names and contents of toxic and/or hazardous substances that Barco’s product may contain. The RoHS of Chinese Mainland is included in the MCV standard of the Ministry of Information Industry of China, in the section “Limit Requirements of toxic substances in Electronic Information Products”.

零件项目(名称)	有毒有害物质或元素					
Component Name	Hazardous Substances or Elements					
	铅 (Pb)	汞 (Hg)	镉 (Cd)	六价铬 (Cr6+)	多溴联苯 (PBB)	多溴二苯醚 (PBDE)
印制电路配件 Printed Circuit Assemblies	x	0	x	0	0	0
电(线)缆 Cables	x	0	x	0	0	0

5. Environmental information

底架 Chassis	x	0	x	0	0	0
电源供应器 Power Supply Unit	x	0	x	0	0	0
文件说明书 Paper Manuals	0	0	0	0	0	0

这个表被制备按照规定SJ/T 11364

This table is prepared in accordance with the provisions of SJ/T 11364.

O: 表示该有毒有害物质在该部件所有均质材料中的含量均在 SJ/T 11363-2006 标准规定的限量要求以下。

O: Indicates that this toxic or hazardous substance contained in all of the homogeneous materials for this part is below the limit requirement in SJ/T11363.

X: 表示该有毒有害物质至少在该部件的某一均质材料中的含量超出 SJ/T 11363-2006 标准规定的限量要求。

X: Indicates that this toxic or hazardous substance contained in at least one of the homogeneous materials used for this part is above the limit requirement in SJ/T11363.

在中国大陆销售的相应电子信息产品(EIP)都必须遵照中国大陆《电子信息产品污染控制标识要求》标准贴上环保使用期限(EFUP)标签。Barco产品所采用的EFUP标签(请参阅实例,徽标内部的编号用于制定产品)基于中国大陆的《电子信息产品环保使用期限通则》标准。

All Electronic Information Products (EIP) that are sold within Chinese Mainland must comply with the "Electronic Information Products Pollution Control Labeling Standard" of Chinese Mainland, marked with the Environmental Friendly Use Period (EFUP) logo. The number inside the EFUP logo that Barco uses (please refer to the photo) is based on the "Standard of Electronic Information Products Environmental Friendly Use Period" of Chinese Mainland.



Image 5-1

5.3 Production address

Factory

Barco N.V.

12F, Citychamp Building, No. 12, Tai Yang Gong Zhong Lu, Chaoyang District, Beijing, P.R.C

Made in information

The made in country is indicated on the product ID label on the product itself.

Production date

The month and year of production is indicated on the product ID label on the product itself.

5.4 Importers contact information

Contact

To find your local importer, contact Barco directly or one of Barco's regional offices via the contact information given on Barco's web site, www.barco.com.